

Pushbutton complete, IP67

Equipment consisting of (schematic overview)

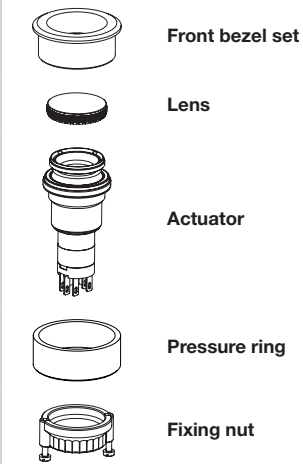

Each Part Number listed below includes all the black components shown in the 3D-drawing.

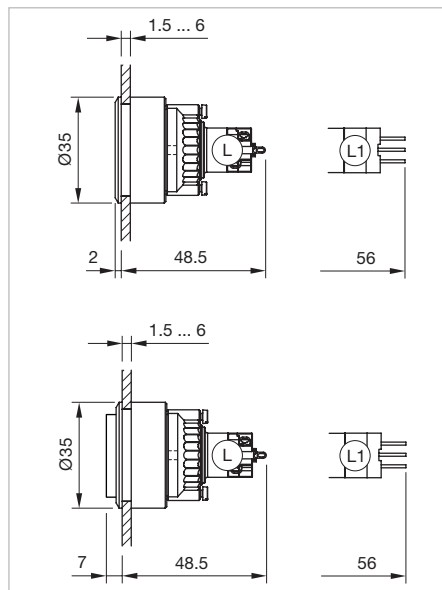



Dimensions [mm]
 L = Solder terminal,
 L1 = Solder/Plug-in terminal 2.8 x 0.8 mm



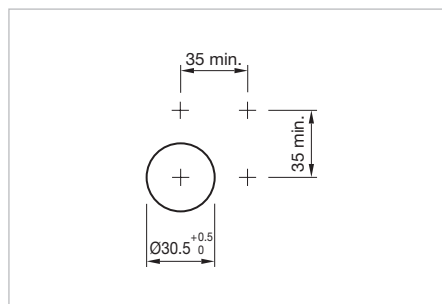







Product can differ from the current configuration.











Mounting cut-outs [mm]

| Lens profile | Lens colour | Contacts | Switching action | Terminal | Part No. | Wiring diagram | Weight |
|---|--|-------------|------------------|-----------------------------|-----------------------|----------------|----------|
|  | Pushbutton, Front dimension Ø 35 mm | | | | | | |
| flush | red anodized | 1 NC + 1 NO | Momentary | Solder/Plug-in 2.8 x 0.8 mm | K14-131.211110 | 1 | 0.031 kg |
|  | Pushbutton, Front dimension Ø 35 mm | | | | | | |
| flush | black anodized | 1 NC + 1 NO | Momentary | Solder/Plug-in 2.8 x 0.8 mm | K14-131.211120 | 1 | 0.031 kg |
|  | Pushbutton, Front dimension Ø 35 mm | | | | | | |
| flush | natural anodized | 1 NC + 1 NO | Momentary | Solder/Plug-in 2.8 x 0.8 mm | K14-131.211130 | 1 | 0.031 kg |

14 Flush design

| Lens profile | Lens colour | Contacts | Switching action | Terminal | Part No. | Wiring diagram | Weight |
|---|--|-------------|------------------|-----------------------------|-----------------------|----------------|----------|
|  | Pushbutton, Front dimension Ø 35 mm | | | | | | |
| flush | green anodized | 1 NC + 1 NO | Momentary | Solder/Plug-in 2.8 x 0.8 mm | K14-131.211140 | 1 | 0.031 kg |
|  | Pushbutton, Front dimension Ø 35 mm | | | | | | |
| flush | blue anodized | 1 NC + 1 NO | Momentary | Solder/Plug-in 2.8 x 0.8 mm | K14-131.211150 | 1 | 0.031 kg |
|  | Pushbutton, Front dimension Ø 35 mm | | | | | | |
| flush | red anodized | 1 NC + 1 NO | Maintained | Solder/Plug-in 2.8 x 0.8 mm | K14-271.212110 | 2 | 0.031 kg |
|  | Pushbutton, Front dimension Ø 35 mm | | | | | | |
| flush | black anodized | 1 NC + 1 NO | Maintained | Solder/Plug-in 2.8 x 0.8 mm | K14-271.212120 | 2 | 0.031 kg |
|  | Pushbutton, Front dimension Ø 35 mm | | | | | | |
| flush | natural anodized | 1 NC + 1 NO | Maintained | Solder/Plug-in 2.8 x 0.8 mm | K14-271.212130 | 2 | 0.031 kg |
|  | Pushbutton, Front dimension Ø 35 mm | | | | | | |
| flush | green anodized | 1 NC + 1 NO | Maintained | Solder/Plug-in 2.8 x 0.8 mm | K14-271.212140 | 2 | 0.031 kg |
|  | Pushbutton, Front dimension Ø 35 mm | | | | | | |
| flush | blue anodized | 1 NC + 1 NO | Maintained | Solder/Plug-in 2.8 x 0.8 mm | K14-271.212150 | 2 | 0.031 kg |
|  | Pushbutton, Front dimension Ø 35 mm | | | | | | |
| flush | red anodized | 1 NC + 1 NO | Momentary | Soldering terminal | K14-131.221110 | 1 | 0.031 kg |
|  | Pushbutton, Front dimension Ø 35 mm | | | | | | |
| flush | black anodized | 1 NC + 1 NO | Momentary | Soldering terminal | K14-131.221120 | 1 | 0.031 kg |

| Lens profile | Lens colour | Contacts | Switching action | Terminal | Part No. | Wiring diagram | Weight |
|---|--|-------------|------------------|--------------------|-----------------------|----------------|----------|
|  | Pushbutton, Front dimension Ø 35 mm | | | | | | |
| flush | natural anodized | 1 NC + 1 NO | Momentary | Soldering terminal | K14-131.221130 | 1 | 0.031 kg |
|  | Pushbutton, Front dimension Ø 35 mm | | | | | | |
| flush | green anodized | 1 NC + 1 NO | Momentary | Soldering terminal | K14-131.221140 | 1 | 0.031 kg |
|  | Pushbutton, Front dimension Ø 35 mm | | | | | | |
| flush | blue anodized | 1 NC + 1 NO | Momentary | Soldering terminal | K14-131.221150 | 1 | 0.031 kg |
|  | Pushbutton, Front dimension Ø 35 mm | | | | | | |
| flush | red anodized | 1 NC + 1 NO | Maintained | Soldering terminal | K14-271.222110 | 2 | 0.031 kg |
|  | Pushbutton, Front dimension Ø 35 mm | | | | | | |
| flush | black anodized | 1 NC + 1 NO | Maintained | Soldering terminal | K14-271.222120 | 2 | 0.031 kg |
|  | Pushbutton, Front dimension Ø 35 mm | | | | | | |
| flush | natural anodized | 1 NC + 1 NO | Maintained | Soldering terminal | K14-271.222130 | 2 | 0.031 kg |
|  | Pushbutton, Front dimension Ø 35 mm | | | | | | |
| flush | green anodized | 1 NC + 1 NO | Maintained | Soldering terminal | K14-271.222140 | 2 | 0.031 kg |
|  | Pushbutton, Front dimension Ø 35 mm | | | | | | |
| flush | blue anodized | 1 NC + 1 NO | Maintained | Soldering terminal | K14-271.222150 | 2 | 0.031 kg |

Contacts: NC = Normally closed, NO = Normally open

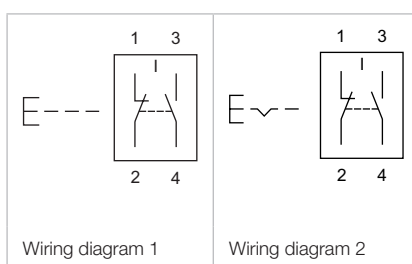

Pushbutton complete, IP67

Equipment consisting of (schematic overview)

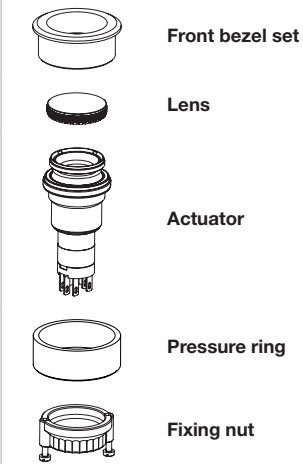

Each Part Number listed below includes all the black components shown in the 3D-drawing.

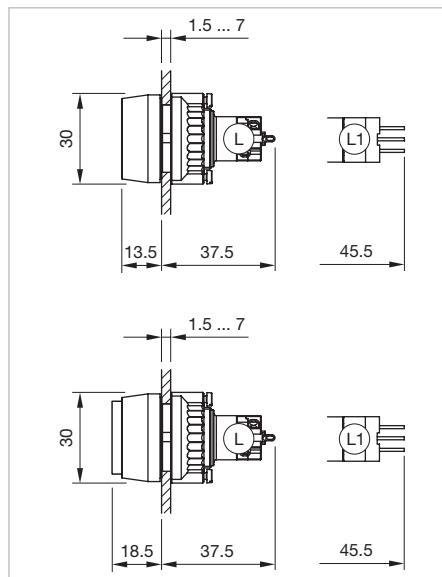



Dimensions [mm]
 L = Solder terminal,
 L1 = Solder/Plug-in terminal 2.8 x 0.8 mm



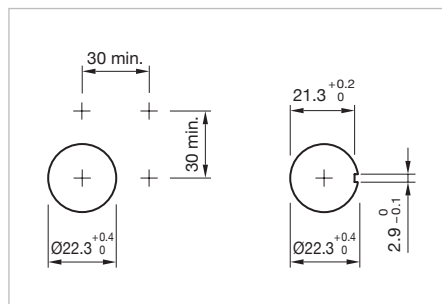







Product can differ from the current configuration.











Mounting cut-outs [mm]

| Lens profile | Lens colour | Contacts | Switching action | Terminal | Part No. | Wiring diagram | Weight |
|---|---|-------------|------------------|-----------------------------|-----------------------|----------------|----------|
|  | Pushbutton, Front dimension \varnothing 29 mm | | | | | | |
| flush | red anodized | 1 NC + 1 NO | Momentary | Solder/Plug-in 2.8 x 0.8 mm | K14-131.111110 | 1 | 0.019 kg |
|  | Pushbutton, Front dimension \varnothing 29 mm | | | | | | |
| flush | black anodized | 1 NC + 1 NO | Momentary | Solder/Plug-in 2.8 x 0.8 mm | K14-131.111120 | 1 | 0.019 kg |
|  | Pushbutton, Front dimension \varnothing 29 mm | | | | | | |
| flush | natural anodized | 1 NC + 1 NO | Momentary | Solder/Plug-in 2.8 x 0.8 mm | K14-131.111130 | 1 | 0.019 kg |

14 Raised design

| Lens profile | Lens colour | Contacts | Switching action | Terminal | Part No. | Wiring diagram | Weight |
|---|--|-------------|------------------|-----------------------------|-----------------------|----------------|----------|
|  | Pushbutton, Front dimension Ø 29 mm | | | | | | |
| flush | green anodized | 1 NC + 1 NO | Momentary | Solder/Plug-in 2.8 x 0.8 mm | K14-131.111140 | 1 | 0.019 kg |
|  | Pushbutton, Front dimension Ø 29 mm | | | | | | |
| flush | blue anodized | 1 NC + 1 NO | Momentary | Solder/Plug-in 2.8 x 0.8 mm | K14-131.111150 | 1 | 0.019 kg |
|  | Pushbutton, Front dimension Ø 29 mm | | | | | | |
| flush | red anodized | 1 NC + 1 NO | Maintained | Solder/Plug-in 2.8 x 0.8 mm | K14-271.112110 | 2 | 0.019 kg |
|  | Pushbutton, Front dimension Ø 29 mm | | | | | | |
| flush | black anodized | 1 NC + 1 NO | Maintained | Solder/Plug-in 2.8 x 0.8 mm | K14-271.112120 | 2 | 0.019 kg |
|  | Pushbutton, Front dimension Ø 29 mm | | | | | | |
| flush | natural anodized | 1 NC + 1 NO | Maintained | Solder/Plug-in 2.8 x 0.8 mm | K14-271.112130 | 2 | 0.019 kg |
|  | Pushbutton, Front dimension Ø 29 mm | | | | | | |
| flush | green anodized | 1 NC + 1 NO | Maintained | Solder/Plug-in 2.8 x 0.8 mm | K14-271.112140 | 2 | 0.019 kg |
|  | Pushbutton, Front dimension Ø 29 mm | | | | | | |
| flush | blue anodized | 1 NC + 1 NO | Maintained | Solder/Plug-in 2.8 x 0.8 mm | K14-271.112150 | 2 | 0.019 kg |
|  | Pushbutton, Front dimension Ø 29 mm | | | | | | |
| flush | red anodized | 1 NC + 1 NO | Momentary | Soldering terminal | K14-131.121110 | 1 | 0.019 kg |
|  | Pushbutton, Front dimension Ø 29 mm | | | | | | |
| flush | black anodized | 1 NC + 1 NO | Momentary | Soldering terminal | K14-131.121120 | 1 | 0.019 kg |

| Lens profile | Lens colour | Contacts | Switching action | Terminal | Part No. | Wiring diagram | Weight |
|---|--|-------------|------------------|--------------------|-----------------------|----------------|----------|
|  | Pushbutton, Front dimension Ø 29 mm | | | | | | |
| flush | natural anodized | 1 NC + 1 NO | Momentary | Soldering terminal | K14-131.121130 | 1 | 0.019 kg |
|  | Pushbutton, Front dimension Ø 29 mm | | | | | | |
| flush | green anodized | 1 NC + 1 NO | Momentary | Soldering terminal | K14-131.121140 | 1 | 0.019 kg |
|  | Pushbutton, Front dimension Ø 29 mm | | | | | | |
| flush | blue anodized | 1 NC + 1 NO | Momentary | Soldering terminal | K14-131.121150 | 1 | 0.019 kg |
|  | Pushbutton, Front dimension Ø 29 mm | | | | | | |
| flush | red anodized | 1 NC + 1 NO | Maintained | Soldering terminal | K14-271.122110 | 2 | 0.019 kg |
|  | Pushbutton, Front dimension Ø 29 mm | | | | | | |
| flush | black anodized | 1 NC + 1 NO | Maintained | Soldering terminal | K14-271.122120 | 2 | 0.019 kg |
|  | Pushbutton, Front dimension Ø 29 mm | | | | | | |
| flush | natural anodized | 1 NC + 1 NO | Maintained | Soldering terminal | K14-271.122130 | 2 | 0.019 kg |
|  | Pushbutton, Front dimension Ø 29 mm | | | | | | |
| flush | green anodized | 1 NC + 1 NO | Maintained | Soldering terminal | K14-271.122140 | 2 | 0.019 kg |
|  | Pushbutton, Front dimension Ø 29 mm | | | | | | |
| flush | blue anodized | 1 NC + 1 NO | Maintained | Soldering terminal | K14-271.122150 | 2 | 0.019 kg |

Contacts: NC = Normally closed, NO = Normally open

