

Description	33
Product Assembly	34
PCB Pushbuttons	35
Accessories	40
Technical Data.....	44
Marking	45
Drawings.....	46
Index.....	159

Product Information

General notes

The series 99 contains indicators and illuminated pushbuttons with maintained and momentary action with one or two contacts which may be either normally open or normally closed or a combination of the two. The illuminated pushbuttons are equipped with the low-level switching system.

The series 99 PCB keylock switch with a spacing of 19.05 mm completes the existing range of indicators and illuminated pushbuttons. The PCB keylock switch is available with two and three positions, with maintained action, and with either one or two normally open contacts as well as with one normally open and one normally closed one.

Mounting

The illuminated pushbuttons of series 99 can be soldered to a printed circuit board. The contact layout conforms to the module of 2.54 mm (1/10 "). A centering pin ensures dimensionally exact mounting in rows or blocks. With an M1.2 screw the pushbuttons can also be fixed to a printed circuit board. (This screw must be ordered separately.) The pushbuttons can be joined together easily with a coupling piece to form rows or blocks. The layout of the PCB keylock switch conforms to the module of 2.54 mm (1/10 "). Two centering pins ensure a dimensionally exact mounting. The contact layout corresponds to that of series 99 switches.

Cleaning of soldered PCB

In many cases the boards are cleaned following mechanical soldering. In this case it is essential to prevent the cleaning fluid containing dirt, grease and flux from entering the switch.

Lenses

The lens consists of a bezel, a marking plate and a transparent lens plate, which may be either flush or concave.

Marking

For further information about engraving, hot stamping and film inserts see part Marking.

Illumination

Illumination of the different coloured lenses is by lamps Bi-Pin T1 longlife (6 ... 36 V) or LED Bi-Pin T1. Luminosity and wave length scattering caused by the technology used in the LED manufacturing processes may lead to visual differences in our products.

Position indication

The status of a maintained action switch can be determined by the position of the lens.

Keylock switch

Standard lock (Index D). 10 different locks with standard nos. 311 ... 320. If the lock number is not specified, we supply no. 311. Additional 125 locks, no. 321 ... 445, are available on request. Master keys for locks no. 311 ... 445 may be ordered by quoting no. 31-989.300. Two keys are supplied with each keylock switch. Spare keys for standard DOM locks may be ordered by quoting no. 31-989 (please state the lock number).

Specimen order

Indicator :

- Indicator actuator single, 18.6 x 18.6 mm 99-050.807

Essential accessories :

- Lens single complete, plastic colourless transparent flush, 18.6 x 18.6 mm 99-901.9
 - Single-LED T1 Bi-Pin, 2.2 VDC, 20 mA, yellow 10-2602.3174C

*We reserve the right to modify technical data
 All dimensions in mm*

Pushbutton illuminative

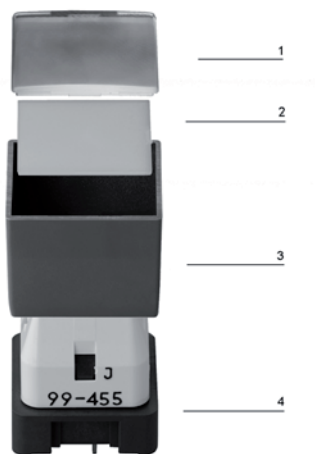



- 1 Lens plate
- 2 Marking plate
- 3 Lens bezel
- 4 Switching element

Indicator actuator single



Essential Accessories:

-  Lens single, complete page 40
-  Single-LED page 43

	Front protection	Terminals	Typ-Nr.	Component layout	Mounting dimensions	Technical drawing	Circuit drawing	
Indicator actuator single	IP 40	P	99-050.807	1	1	1	1	0.006



Terminals: P = PCB terminal

Component layout from page 46, Mounting dimensions from page 47, Technical drawing from page 48, Circuit drawing from page 49

Indicator actuator double



Essential Accessories:

-  Lens plate double page 41
-  Marking plate double page 41
-  Single-LED page 43

	Front protection	Terminals	Typ-Nr.	Component layout	Mounting dimensions	Technical drawing	Circuit drawing	
Indicator actuator double	IP 40	P	99-052.807	2	1	2	22	0.011



Terminals: P = PCB terminal

Component layout from page 46, Mounting dimensions from page 47, Technical drawing from page 48, Circuit drawing from page 49

Indicator actuator triple



Essential Accessories:

-  Lens plate triple page 41
-  Marking plate triple page 41
-  Single-LED page 43

	Front protection	Terminals	Dimensions □ 18.6 x 56.9 mm Typ-Nr.	Component layout	Mounting dimensions	Technical drawing	Circuit drawing	
Indicator actuator triple	IP 40	P	99-053.807	3	1	3	23	0.017

Terminals: P = PCB terminal

Component layout from page 46, Mounting dimensions from page 47, Technical drawing from page 48, Circuit drawing from page 49

Illuminated pushbutton actuator single



Essential Accessories:

- Lens single, complete page 40
- Single-LED page 43

	Front protection	Contacts	Switching action	point of pressure	Terminals	18.6 x 18.6 mm Typ-Nr.	Component layout	Mounting dimensions	Technical drawing	Circuit drawing	
Illuminated pushbutton actuator single	IP 40	1 NC	MA	with	P	99-482.837	1	1	1	2	0.008
				without	P	99-487.837	1	1	1	2	0.008
			M	with	P	99-452.837	1	1	1	10	0.008
				without	P	99-457.837	1	1	1	10	0.008
		1 NC + 1 NO	MA	with	P	99-483.837	1	1	1	4	0.008
				without	P	99-488.837	1	1	1	4	0.008
			M	with	P	99-453.837	1	1	1	12	0.008
				without	P	99-458.837	1	1	1	12	0.008
		1 NO	MA	with	P	99-480.837	1	1	1	3	0.008
				without	P	99-485.837	1	1	1	3	0.008
			M	with	P	99-450.837	1	1	1	11	0.008
				without	P	99-455.837	1	1	1	11	0.008
		2 NO	MA	with	P	99-481.837	1	1	1	7	0.008
				without	P	99-486.837	1	1	1	7	0.008
			M	with	P	99-451.837	1	1	1	15	0.008
				without	P	99-456.837	1	1	1	15	0.008

Contacts: NC = Normally closed, NO = Normally open

Switching action: MA = Maintained action, M = Momentary action



Terminals: P = PCB terminal

Component layout from page 46, Mounting dimensions from page 47, Technical drawing from page 48, Circuit drawing from page 49

Illuminated pushbutton actuator double



Essential Accessories:

-  Lens plate double page 41
-  Marking plate double page 41
-  Single-LED page 43

	Front protection	Contacts	Switching action	Terminals	□ 18.6 x 37.8 Typ-Nr.	Component layout	Mounting dimensions	Technical drawing	Circuit drawing	
Illuminated pushbutton actuator double	IP 40	1 NC + 1 NO	MA	P	99-418.837	2	1	2	5	0.013
			M	P	99-408.837	2	1	2	13	0.013
		2 NO	MA	P	99-416.837	2	1	2	8	0.013
			M	P	99-406.837	2	1	2	16	0.013

Contacts: NC = Normally closed, NO = Normally open

Switching action: MA = Maintained action, M = Momentary action



Terminals: P = PCB terminal

Component layout from page 46, Mounting dimensions from page 47, Technical drawing from page 48, Circuit drawing from page 49

Illuminated pushbutton actuator triple



Essential Accessories:

-  Lens plate triple page 41
-  Marking plate triple page 41
-  Single-LED page 43

	Front protection	Contacts	Switching action	Terminals	□ 18.6 x 56.9 Typ-Nr.	Component layout	Mounting dimensions	Technical drawing	Circuit drawing	
Illuminated pushbutton actuator triple	IP 40	1 NC + 1 NO	MA	P	99-448.837	3	1	3	6	0.019
			M	P	99-438.837	3	1	3	14	0.019
		2 NO	MA	P	99-446.837	3	1	3	9	0.019
			M	P	99-436.837	3	1	3	17	0.019

Contacts: NC = Normally closed, NO = Normally open

Switching action: MA = Maintained action, M = Momentary action

Terminals: P = PCB terminal

Component layout from page 46, Mounting dimensions from page 47, Technical drawing from page 48, Circuit drawing from page 49

Keylock switch 2 positions

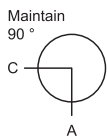

	Front protection	Contacts	Switching action	Terminals	Key remove	Ø 18.8 x 18.8 mm Typ-Nr.	Component layout	Mounting dimensions	Technical drawing	Circuit drawing		
							1	2	4	20		0.017
Keylock switch 2 positions Position A: Basic position Position C: Maintained action Standard lock 311	IP 40	1 NC + 1 NO	MA	P	A	99-213.837D	1	2	4	20	0.017	
					C	99-233.837D	1	2	4	20	0.017	
					C + A	99-253.837D	1	2	4	20	0.017	
		1 NO	MA	P	A	99-210.837D	1	2	4	18	0.017	
					C	99-230.837D	1	2	4	18	0.017	
					C + A	99-250.837D	1	2	4	18	0.017	
	2 NO	MA	P	A	99-211.837D	1	2	4	21	0.017		
				C	99-231.837D	1	2	4	21	0.017		
				C + A	99-251.837D	1	2	4	21	0.017		

Other lock numbers on request

Contacts: NC = Normally closed, NO = Normally open

Switching action: MA = Maintained action

Terminals: P = PCB terminal

Component layout from page 46, Mounting dimensions from page 47, Technical drawing from page 48, Circuit drawing from page 49

Keylock switch 3 positions

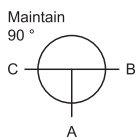

	Front protection	Contacts	Switching action	Terminals	Key remove	Ø 18.8 x 18.8 mm Typ-Nr.	Component layout	Mounting dimensions	Technical drawing	Circuit drawing		
							1	2	4	19		0.017
Keylock switch 3 positions Position C: Maintained action Position A: Basic position Position B: Maintained action Standard lock 311	IP 40	2 NO	MA-0-MA	P	A	99-311.837D	1	2	4	19	0.017	
					A + B	99-341.837D	1	2	4	19	0.017	
					B	99-321.837D	1	2	4	19	0.017	
					C	99-331.837D	1	2	4	19	0.017	
					C + A	99-351.837D	1	2	4	19	0.017	
					C + A + B	99-371.837D	1	2	4	19	0.017	
					C + B	99-361.837D	1	2	4	19	0.017	

Other lock numbers on request

Contacts: NO = Normally open

Switching action: MA = Maintained action

Terminals: P = PCB terminal

Component layout from page 46, Mounting dimensions from page 47, Technical drawing from page 48, Circuit drawing from page 49

Front

Lens single, complete

for single pushbutton

	Pressure plate	∅ 18.6 x 18.6 mm Typ-Nr.	
Lens single, complete concave	Plastic colourless transparent	99-902.9	0.002
flush	Plastic colourless transparent	99-901.9	0.002



Lens plate single

for single pushbutton

	Pressure plate	∅ 18.6 x 18.6 mm Typ-Nr.	
Lens plate single concave	Plastic colourless transparent	99-922.7	0.001
	Plastic grey opaque	99-924.8	0.001
concave, mat	Plastic colourless transparent	99-928.7	0.001
convex	Plastic colourless transparent	99-929.7A	0.001
convex with recess	Plastic colourless transparent	99-928.7A	0.001
flush	Plastic colourless transparent	99-921.7	0.001
flush, mat	Plastic colourless transparent	99-927.7	0.001



Marking plate single

for lens single

	Marking plate	∅ 18.6 x 18.6 mm Typ-Nr.	
Marking plate single can be engraved or hot stamped	Plastic black translucent	99-908.0	0.001
	Plastic white translucent	99-908.9	0.001
for LED	Plastic beige translucent	99-918.A	0.001



Lens bezel single

for single pushbutton

	Lens bezel	Typ-Nr.	
Lens bezel single rounded	Plastic grey	99-920.82	0.001
	Plastic beige	99-920.9B	0.001
with edges	Plastic black	99-920.0	0.001
	Plastic brown	99-920.9C	0.001
	Plastic grey	99-920.8	0.001
	Plastic white	99-920.9A	0.001



Lens plate double

for pushbutton double

	Pressure plate	□ 18.6 x 37.8 mm Typ-Nr.	
Lens plate double concave	Plastic colourless transparent	99-962.7	0.001
concave, mat	Plastic colourless transparent	99-974.7	0.001
flush	Plastic colourless transparent	99-961.7	0.001
	Plastic white transparent	99-961.9	0.001
flush, mat	Plastic colourless transparent	99-973.7	0.001



Marking plate double

for lens double

	Marking plate	□ 18.6 x 37.8 mm Typ-Nr.	
Marking plate double can be engraved or hot stamped	Plastic black translucent	99-963.0	0.001
	Plastic white translucent	99-963.9	0.001



Lens plate triple

for pushbutton triple

	Pressure plate	□ 18.6 x 56.9 mm Typ-Nr.	
Lens plate triple concave	Plastic colourless transparent	99-967.7	0.002
concave, mat	Plastic colourless transparent	99-979.7	0.002
flush	Plastic colourless transparent	99-966.7	0.002
flush, mat	Plastic colourless transparent	99-978.7	0.002



Marking plate triple

for pushbutton triple

	Marking plate	□ 18.6 x 56.9 mm Typ-Nr.	
Marking plate triple can be engraved or hot stamped	Plastic black translucent	99-968.0	0.001
	Plastic white translucent	99-968.9	0.001



Colour foil single

for lens single

	Colour foil	□ 18.6 x 18.6 mm Typ-Nr.	
Colour foil single	blue	99-909.6	1.001
	green	99-909.5	1.001
	orange	99-909.3	1.001
	red	99-909.2	1.001
	yellow	99-909.4	1.001



Colour foil double

for lens double

	Colour foil	□ 18.6 x 37.8 mm Typ-Nr.	
Colour foil double	blue	99-964.6	0.001
	green	99-964.5	0.001
	red	99-964.2	0.001
	yellow	99-964.4	0.001



Colour foil triple

for lens triple

	Colour foil	□ 18.6 x 56.9 mm Typ-Nr.	
Colour foil triple	blue	99-969.6	0.001
	green	99-969.5	0.001
	red	99-969.2	0.001
	yellow	99-969.4	0.001



Blind plug

	Blind plug	□ 19 x 19 mm Typ-Nr.	
Blind plug H = 16 mm	Plastic grey	99-948.81	0.003
H = 17.5 mm	Plastic grey	99-948.82	0.003
H = 19 mm	Plastic grey	99-948.83	0.004



Spare key

	Typ-Nr.	
Spare key Key lock switch, standard lock 311 (DOM)	31-989.311	0.006



Other lock numbers on request

Illumination

Filament lamp

up to pushbutton order 1, 2 or 3 pcs.

	Socket	Operating voltage/-current	Typ-Nr.	
Filament lamp	T1 Bi-Pin	12 VAC/DC, 25 mA	10-1609.1199	0.001
		24 VAC/DC, 20 mA	10-1612.1179	0.001
		28 VAC/DC, 24 mA	10-1613.1189	0.001
		36 VAC/DC, 20 mA	10-1616.1179	0.001
		6 VAC/DC, 70 mA	10-1606.1309	0.001



Single-LED

up to pushbutton order 1, 2 or 3 pcs.

	Socket	Light colour	Operating voltage/-current	Typ-Nr.	
Single-LED	T1 Bi-Pin	green	2.2 VDC, 20 mA	10-2602.3175C	0.001
		red	2.2 VDC, 20 mA	10-2602.3172C	0.001
		white	3.6 VDC, 20 mA	10-2603.3179C	0.001
		yellow	2.2 VDC, 20 mA	10-2602.3174C	0.001



Multi-LED

up to pushbutton order 1, 2 or 3 pcs.

	Socket	Light colour	Operating voltage/-current	Typ-Nr.	
Multi-LED	T1 Bi-Pin	green	28 VDC, 12 mA	10-4613.3105B	0.001
		orange	28 VDC, 12 mA	10-4613.3103B	0.001
		red	28 VDC, 12 mA	10-4613.3102B	0.001
		yellow	28 VDC, 12 mA	10-4613.3104B	0.001



Assembling

Coupling section

for mounting pushbuttons in rows or blocks

	Typ-Nr.	
Coupling section grey	99-910	0.001



Fixing screw

	Typ-Nr.	
Fixing screw M 1.2 x 5 mm (DIN)	99-990	0.001

Lamp remover

	Typ-Nr.	
Lamp remover	11-906	0.003



CAUTION

A switching process might be released when replacing the Lamp/LED !

Low level switching element

Switching system

This low-level switching system was designed for switching low powers in electronic circuits. The switching system assures reliable switching of loads.

Single-break momentary contact, as normally open or normally closed with 4 independent points of contact.

Special features are the long life, extremely short rebound time and stable contact resistance.

Contact combinations: 1 normally open contact, 2 normally open contacts, 1 normally closed/1 normally open contact, 1 normally closed contact

Material

Material of contact

Gold plated

Switching element

Polycarbonate (PC)

Mechanical characteristics

Rebound time

≤100 μs typical

Mechanical lifetime

Illuminated pushbutton	5 million operations
PCB keylock switch	50 000 operations

Electrical characteristics

Contact resistance

Starting value (initial) ≤50 mΩ as per IEC 60512-2-2b

Isolation resistance

10¹² Ω between contacts at 100 VDC, as per IEC 60512-2-3a

Switch rating

min. 100 μVDC/AC, 10 μA
max. 42 VDC/AC, 100 mA

Electric strength

2500 VAC, 50 Hz, 1 min. between all terminals and earth, as per IEC 60512-2-11

Environmental conditions

Storage temperature

-40 °C ... +85 °C

Service temperature

-25 °C ... +55 °C
for indicators and illuminated pushbuttons mounted as a block, make sure the heat can escape freely

Shock resistance

(single impacts, semi-sinusoidal)
15 g for 11 ms as per IEC 6068-2-27

Actuator

Material

Lens plate

Polymethylmethacrylate (PMMA), heat-resistant

Lens bezel

Polycarbonate (PC), heat-resistant

Mechanical characteristics

Actuating torque

4.7 Ncm ... 6.0 Ncm (measured at the key)

Actuating force

Pushbutton with tactile point	2.0 ±0.3 N
Pushbutton without tactile point	1.3 ±0.4 N

Actuating travel

Lead distance NC contact 1.1 ±0.2 mm
Lead distance NO contact 2.1 ±0.2 mm
total distance 3.6 ±0.2 mm

Angle of rotation for print keylock switch

Keylock switch with 2 positions 90°
Keylock switch with 3 positions 2 x 90°

Mechanical lifetime

Illuminated pushbutton	5 million operations
PCB keylock switch	50 000 operations

Electrical characteristics

Electrostatic discharge (ESD)

10 kV

Environmental conditions

Storage temperature

-40 °C ... +85 °C

Service temperature

-25 °C ... +55 °C
for indicators and illuminated pushbuttons mounted as a block, make sure the heat can escape freely

Protection degree

frontside IP 40, PCB keylock switch, illuminated pushbutton

General notes

1. Engraving

In addition to the most commonly used world languages, in DIN 1451-3 close spacing, other typefaces are available as Scandinavian, Slavic, Greek, Russian and Polish.

Unless requested otherwise by customer, the lettering on white and black marking plates will be in black or white.

Standard height of letters is 2 mm. If the height is not specified, we will supply 2 mm engraved letters.

2. Hot stamping

For larger series it is worth considering markings by means of hot stamping or laser engraving. We will be pleased to advise you.

For letters and figures, typefaces with 2.5 mm, 3 mm and 4 mm are available.

3. Film inserts

Instead of using engraving the lenses can be fitted with transparent film inserts, possibly backed by a colour foil placed between the lens plate and the marking plate, as an alternative.

The film thickness is 0.2 mm.

Maximum film size:

for single pushbutton 16 x 16 mm

for double pushbutton 16 x 34.7 mm

for triple pushbutton 16 x 53.8 mm.

Lenses for Indicators | Illuminated pushbuttons

All dimensions in mm

Front size	Film insert max. size	Height of letters h	Number of lines	Number of (target value) capital letters per line	Number of (target value) small letters per line	Image
18.6 x 18.6	16 x 16	2	4	7	8	B1
		3	3	6	7	B1
		4	2	4	5	B1
		5	2	3	4	B1
		6	1	3	4	B1
		8	1	2	3	B1
18.6 x 37.8	16 x 34.7	2	4	19	20	B2
		3	3	16	18	B2
		4	2	11	13	B2
		5	2	9	10	B2
		6	1	7	8	B2
		8	1	5	6	B2
18.6 x 56.9	16 x 53.8	2	4	30	32	B3
		3	3	25	28	B3
		4	2	18	20	B3
		5	2	14	16	B3
		6	1	12	13	B3
		8	1	9	10	B3

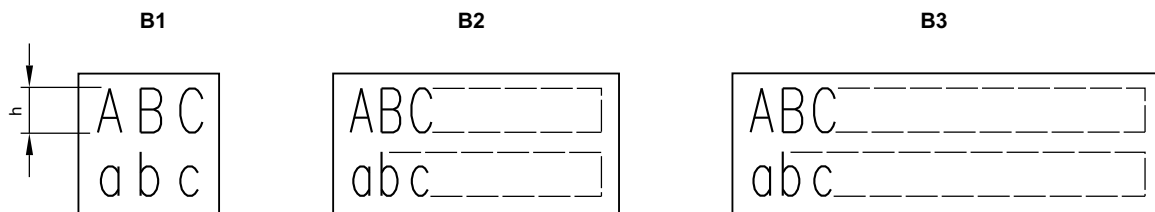

Component layout

1 Indicator actuator single page 35 | **Illuminated pushbutton actuator single** page 37 | **Keylock switch 2 positions** page 39 | **Keylock switch 3 positions** page 39

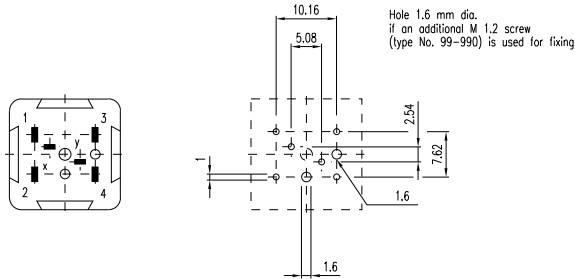

Libraries for the PCB layout-system p-cad 200X see : www.pcad.com/resources/libraries Third-party Libraries

2 Indicator actuator double page 35 | **Illuminated pushbutton actuator double** page 38

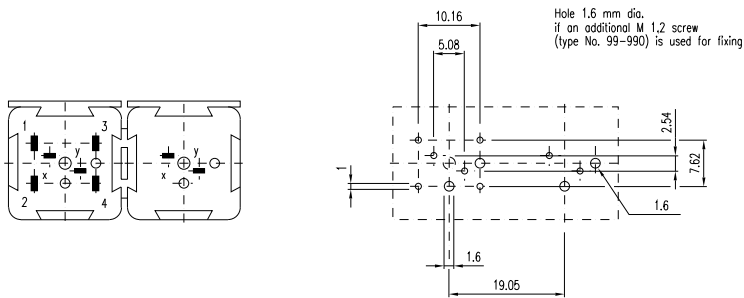

Libraries for the PCB layout-system p-cad 200X see : www.pcad.com/resources/libraries Third-party Libraries

3 Indicator actuator triple page 36 | **Illuminated pushbutton actuator triple** page 38

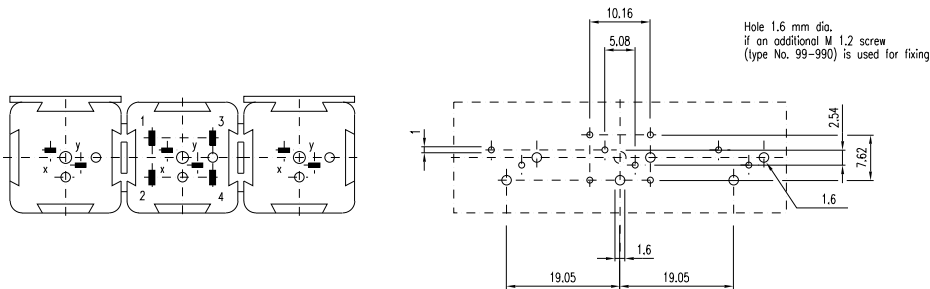

Libraries for the PCB layout-system p-cad 200X see : www.pcad.com/resources/libraries Third-party Libraries

Mounting dimensions

1 Indicator actuator single page 35 | Indicator actuator double page 35 | Indicator actuator triple page 36 | Illuminated pushbutton actuator single page 37 | Illuminated pushbutton actuator double page 38 | Illuminated pushbutton actuator triple page 38

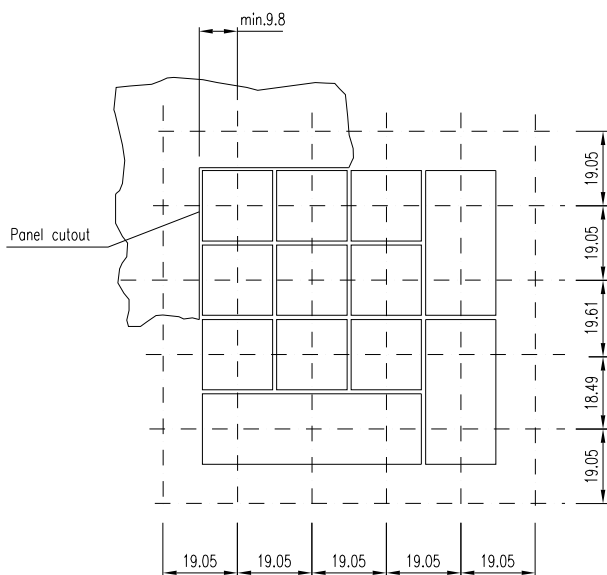

2 Keylock switch 2 positions page 39 | Keylock switch 3 positions page 39

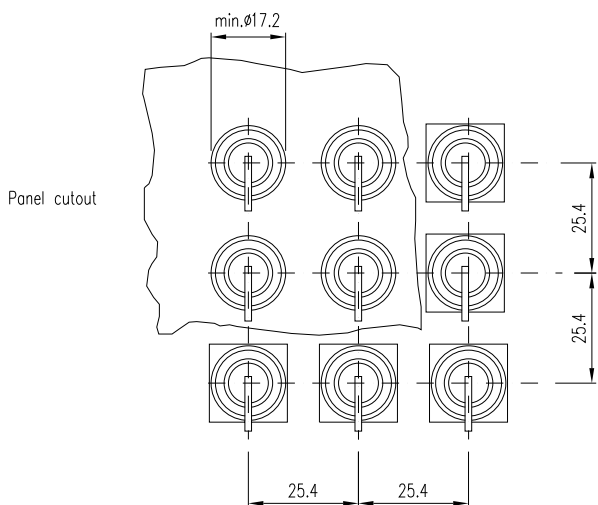

Technical drawing

1 Indicator actuator single page 35 | Illuminated pushbutton actuator single page 37

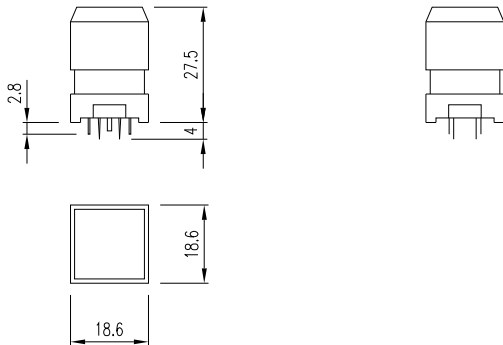

2 Indicator actuator double page 35 | Illuminated pushbutton actuator double page 38

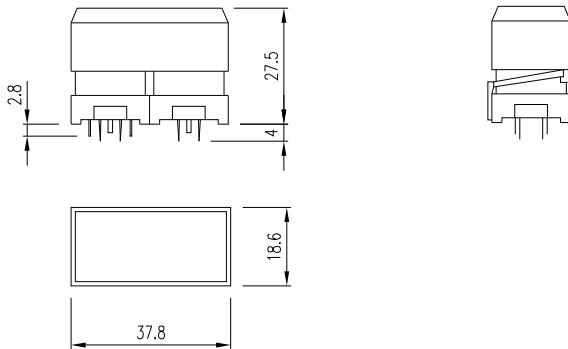

3 Indicator actuator triple page 36 | Illuminated pushbutton actuator triple page 38

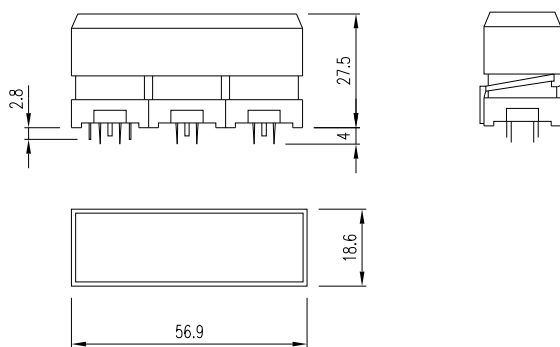

4 Keylock switch 2 positions page 39 | Keylock switch 3 positions page 39

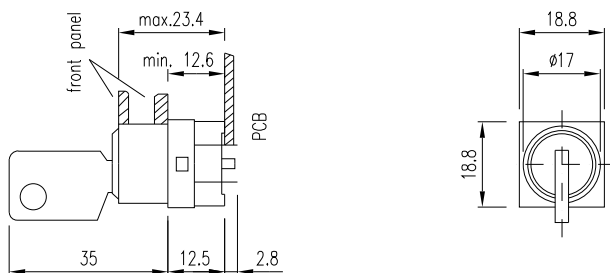

Circuit drawing

1 Indicator actuator single page 35



2 Illuminated pushbutton actuator single page 37

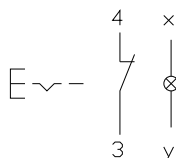

3 Illuminated pushbutton actuator single page 37

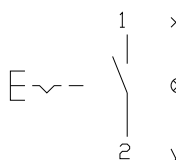

4 Illuminated pushbutton actuator single page 37

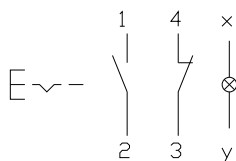

5 Illuminated pushbutton actuator double page 38

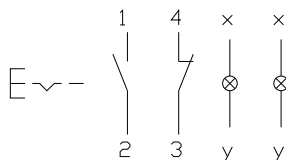

6 Illuminated pushbutton actuator triple page 38

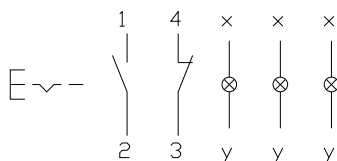

7 Illuminated pushbutton actuator single page 37

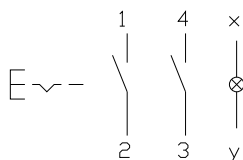

8 Illuminated pushbutton actuator double page 38

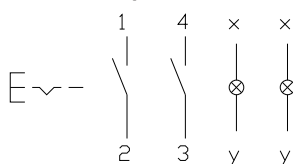

9 Illuminated pushbutton actuator triple page 38

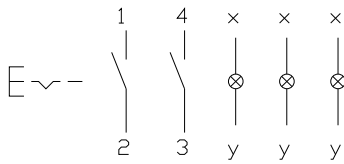

10 Illuminated pushbutton actuator single page 37

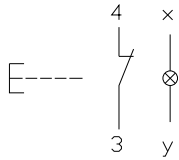

11 Illuminated pushbutton actuator single page 37

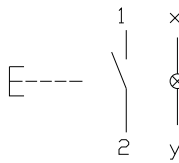

12 Illuminated pushbutton actuator single page 37

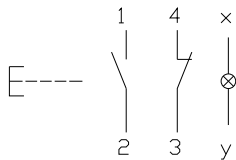

13 Illuminated pushbutton actuator double page 38

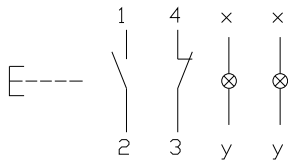

14 Illuminated pushbutton actuator triple page 38

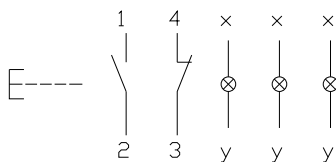

15 Illuminated pushbutton actuator single page 37

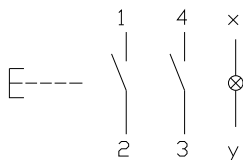

16 Illuminated pushbutton actuator double page 38

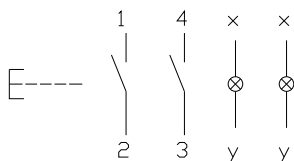

17 Illuminated pushbutton actuator triple page 38

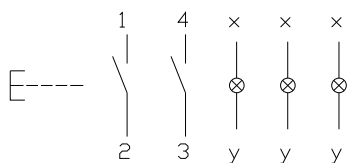

18 Keylock switch 2 positions page 39

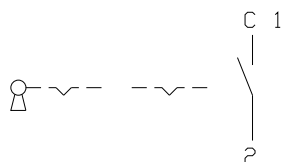

19 Keylock switch 3 positions page 39



20 Keylock switch 2 positions page 39

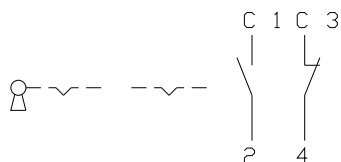

21 Keylock switch 2 positions page 39

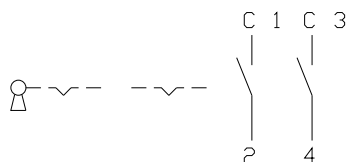

22 Indicator actuator double page 35

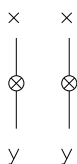

23 Indicator actuator triple page 36

