







Pushbutton for ring illumination (multicolor) PCB or Halo Compact, IP 67

Equipment consisting of (schematic overview)

-  **Lens** page 24
-  **Actuator**
-  **Fixing nut**
-  **Mounting flange** page 37
-  **LED** page 39
-  **Switching element** page 34

Each Part Number listed below includes all the black components shown in the 3D-drawing.

To obtain a complete unit, please select the red components from the pages shown.

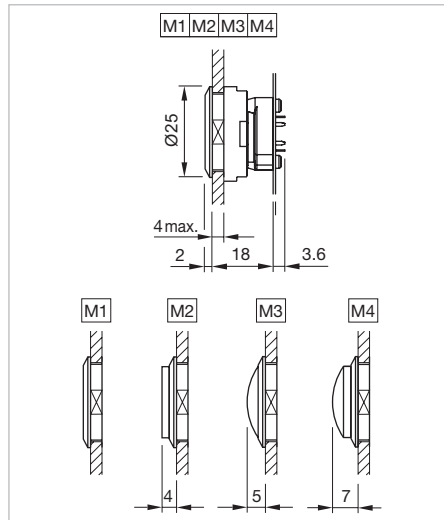

Dimensions [mm]
 M1 = Lens level with bezel,
 M2 = Lens raised above bezel,
 M3 = Lens konvexe level with bezel,
 M4 = Lens konvexe raised above bezel



Product can differ from the current configuration.

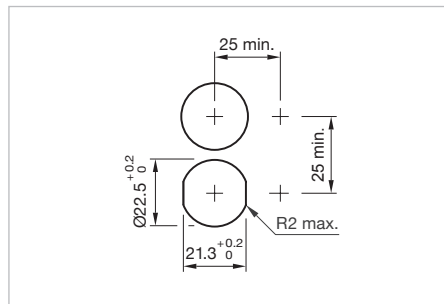

Mounting cut-outs [mm]

Additional Information

- The LEDs are not part of delivery.
 Recommendation: Osram Hyper Mini TOPLED

Front ring	Switching action	Part No.	Wiring diagram	Weight
				
Pushbutton actuator for ring illumination (multicolor) PCB or Halo Compact, Front dimension Ø 25 mm				
Plastic colourless transparent	B	84-1081.7	1	0.006 kg

Switching action: B = Momentary

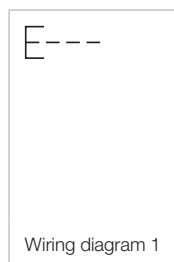

Wiring diagram 1

Front

Lens plastic

Additional Information

- Lens profile flat

Product attribute	Dimension	Lens	Mounting type	Part No.	Weight
 <p>Lens plastic</p>					
illuminative	Ø 19.7 mm	red transparent	level with bezel	84-7111.200	0.001 kg
		orange transparent	level with bezel	84-7111.300	0.001 kg
		yellow transparent	level with bezel	84-7111.400	0.001 kg
		green transparent	level with bezel	84-7111.500	0.001 kg
		blue transparent	level with bezel	84-7111.600	0.001 kg
		colourless transparent	level with bezel	84-7111.700	0.001 kg
non-illuminative	Ø 19.7 mm	black opaque	level with bezel	84-7121.000	0.001 kg
		grey opaque	level with bezel	84-7121.800	0.001 kg
illuminative	Ø 19.7 mm	red transparent	raised above bezel	84-7115.200	0.001 kg
		orange transparent	raised above bezel	84-7115.300	0.001 kg
		yellow transparent	raised above bezel	84-7115.400	0.001 kg
		green transparent	raised above bezel	84-7115.500	0.001 kg
		blue transparent	raised above bezel	84-7115.600	0.001 kg
		colourless transparent	raised above bezel	84-7115.700	0.001 kg
non-illuminative	Ø 19.7 mm	black opaque	raised above bezel	84-7125.000	0.001 kg
		grey opaque	raised above bezel	84-7125.800	0.001 kg

Marking plate

Additional Information

- Can be hot stamped

Marking plate	Part No.	Weight
 <p>Legend plate for lens plastic</p>		
Plastic colourless transparent	61-9707.7	0.001 kg

Illumination element PCB

Additional Information

- The customer has to decide what series resistor shall be used to the LED
- LED and mounting flange to be ordered separately

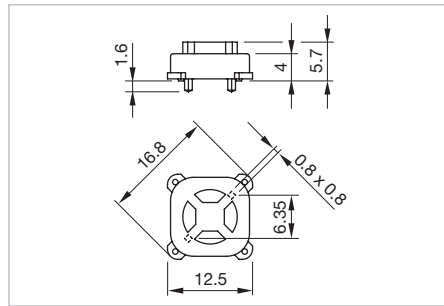

Dimensions [mm]



Terminal	Part No.	Component layout	Weight
 <p>Illumination element PCB mounting</p>			
PCB	92-800.042	4	0.001 kg

The component layouts you will find from page 49

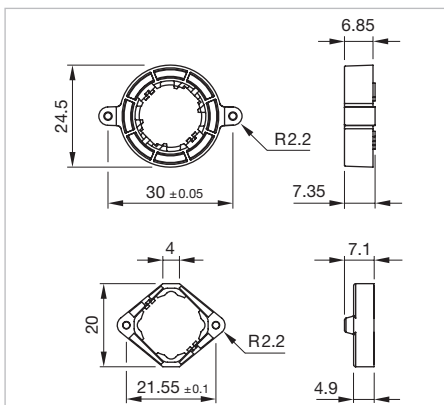
Mounting flange



Dimensions [mm]

Product attribute	Part No.	Weight
 <p>Mounting flange</p>		
Halo illumination (illuminated multi-color bezel)	84-960.0	0.001 kg
 <p>Mounting flange</p>		
Standard version	92-960.0	0.001 kg

Illumination

Single-LED, T1 Bi-Pin

Additional Information

- The customer has to decide what series resistor shall be used to the LED
- Luminosity and wave length scattering caused by LED manufacturing processes may cause slight variations in the illumination

LED colour	Forward voltage typ.	Lumi. intensity	Dom. wavelength	Part No.	Weight
 <p>Single-LED</p>					
Single-LED red	2.1 VDC @ 20 mA	200 mcd	625 nm	10-2602.3202L	0.001 kg
Single-LED orange	2.1 VDC @ 20 mA	220 mcd	590 nm	10-2602.3203L	0.001 kg
Single-LED yellow	3.3 VDC @ 20 mA	500 mcd	570 nm	10-2602.3204L	0.001 kg
Single-LED green	3.5 VDC @ 20 mA	250 mcd	525 nm	10-2602.3205L	0.001 kg
Single-LED blue	3.5 VDC @ 20 mA	450 mcd	470 nm	10-2602.3206L	0.001 kg
Single-LED white	3.3 VDC @ 20 mA	600 mcd	x=0.29/y=0.31 nm	10-2602.3209L	0.001 kg

Bi-colour-LED, T1 Bi-Pin

Additional Information

- The customer has to decide what series resistor shall be used to the LED
- Luminosity and wave length scattering caused by LED manufacturing processes may cause slight variations in the illumination

LED colour	Forward voltage typ.	Lumi. intensity	Dom. wavelength	Part No.	Weight
 <p>Bi-colour-LED</p>					
Bi-colour LED red/green	2.0/3.2 VDC @ 20 mA	380/650 mcd	628/525 nm	10-2603.320AL	0.001 kg
Bi-colour LED yellow/green	2.0/3.2 VDC @ 20 mA	480/380 mcd	588/525 nm	10-2603.320CL	0.001 kg

84 Accessories

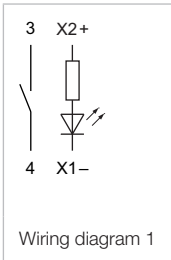

Switching element bi-colour

- Additional Information**
- LED and built-in resistor included
 - Protection degree IP 67, rear side fully sealed. The switching element cannot be disconnected from the actuator any longer
 - Best illumination level will be reached with aluminium lens with spot, Part No. 84-7215.x00 and 84-7211.x00
 - Standard version: Cable length 300 mm with insulated ferrule
 - Other options on request: Customisation of cable and connectors
 - Luminosity and wave length variations caused by LED manufacturing processes may cause slight differences regarding the illumination

Protection degree	LED colour	Operating voltage	Operation current	Contacts	Terminal	Part No.	Wiring diagram	Weight
 <p>Switching element with bi-colour illumination</p>								
IP 67	Bi-colour LED red/green	24 VDC ±10 %	20 mA	1 NO	Flat ribbon cable	84-8515.8640	1	0.015 kg
	Bi-colour LED yellow/green	24 VDC ±10 %	20 mA	1 NO	Flat ribbon cable	84-8515.7640	1	0.015 kg

Contacts: NO = Normally open

